

VIGO 180 Variations

Xonyx™ solid surface bath

MATERIAL: Solid surface

SHAPE: Rectangular

INSTALLATION:

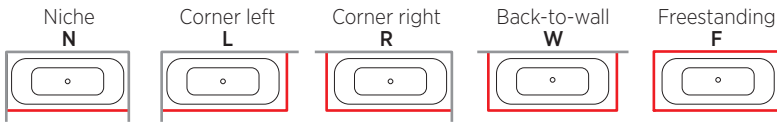

EXTERIOR DIMENSIONS (LxWxH): 180 x 80 x 65 cm

PRODUCT WEIGHT: 95 / 105 / 105 / 120 / 150 kg

WATER CAPACITY: 300 l

COLOR OPTIONS:

1) Standard white (white interior / white exterior)

2) Bi-colored (white interior / colored* exterior)

*According to RAL Classic color pallet



WASTE: Click-clack stopper, solid surface coated cap, white

DRAIN: Siphon included. 40 mm connection pipe required

OVERFLOW: Integrated

PACKAGE: On a pallet in wooden crate

PACKAGE DIMENSIONS (LxWxH): 196 x 107 x 85 cm

ORIGIN: European

STANDARDS:

› EN 14516:2015+A1:2018

› ISO 19712-3

› CSA B45.5-22/IAPMO Z124-2022



PRODUCT INCLUDES:

› Bathtub with integrated overflow and waste

› Support frame with adjustable feet

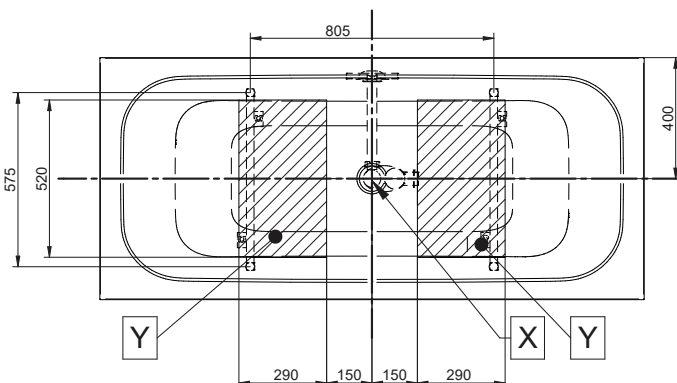
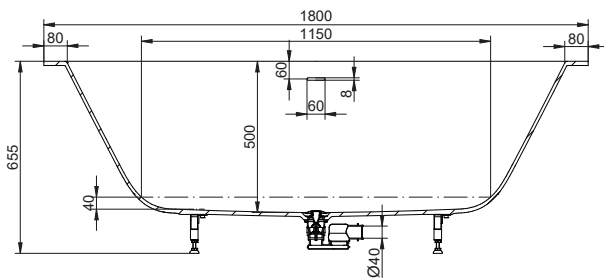

Product measure tolerances ± 10 mm

Frame location tolerance according to X ± 20 mm

X - Bathtub drain centre

Y - Suggested floor drainage area



WHAT IS XONYX?

- › Unique solid surface polymer composite material created by Balteco R&D
- › Mixture of ATH (Aluminium Tri-hydrate), polyester resin with acrylic compounds and carefully selected additives
- › Material with superior structural strength and scratch resistant hard surface.

MATERIAL BENEFITS:

- › Novel Silky Smooth surface
- › Extra durable monolith
- › Scratch resistant hard surface
- › 100 % homogeneous material
- › Bacteria resistant
- › Superior cleaning properties
- › Calm white
- › Seamless bonding
- › Renewable and repairable

