

# AZUR 140

Xonyx™ solid surface bath

**MATERIAL:** Solid surface

**SHAPE:** Oval

**INSTALLATION:** Freestanding

**EXTERIOR DIMENSIONS (LxWxH):** 140 x 70 x 62 cm

**PRODUCT WEIGHT:** 90 kg

**WATER CAPACITY:** 215 l

**COLOR OPTIONS:**

1) Standard white (white interior / white exterior)

2) Bi-colored (white interior / colored\* exterior)

\*According to RAL Classic color pallet



**WASTE:** Click-clack stopper, solid surface coated cap, white

**DRAIN:** Siphon included. 40 mm connection pipe required

**OVERFLOW:** Integrated

**FILLER OPTIONS:** Wall-mount, floor-mount

**PACKAGE:** On a pallet in wooden crate

**PACKAGE DIMENSIONS (LxWxH):** 196 x 107 x 85 cm

**ORIGIN:** European

**STANDARDS:**

› EN 14516:2015+A1:2018

› ISO 19712-3

› CSA B45.5-22/IAPMO Z124-2022



**PRODUCT INCLUDES:**

› Bathtub with integrated overflow and waste

› Support frame with adjustable feet



## WHAT IS XONYX?

- › Unique solid surface polymer composite material created by Balteco R&D
- › Mixture of ATH (Aluminium Tri-hydrate), polyester resin with acrylic compounds and carefully selected additives
- › Material with superior structural strength and scratch resistant hard surface.

## MATERIAL BENEFITS:

- › Novel Silky Smooth surface
- › Extra durable monolith
- › Scratch resistant hard surface
- › 100 % homogeneous material
- › Bacteria resistant
- › Superior cleaning properties
- › Calm white
- › Seamless bonding
- › Renewable and repairable

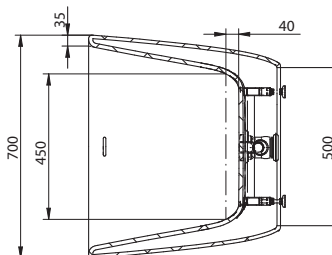
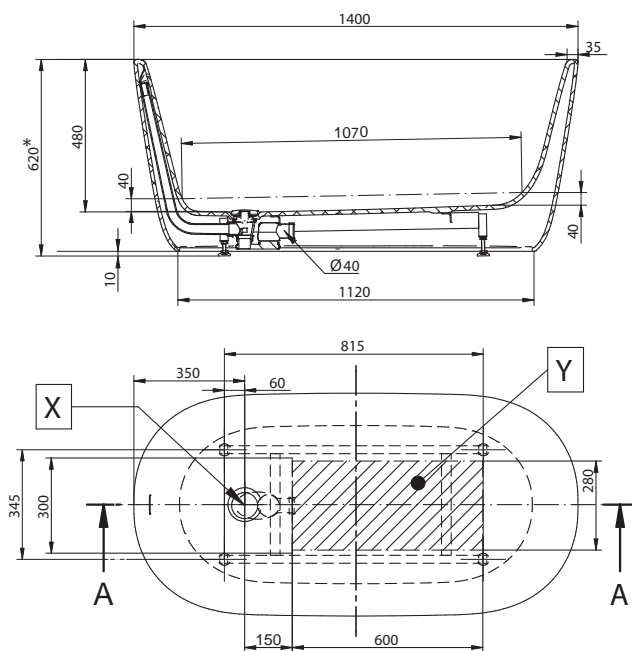

Product measure tolerances ± 10 mm  
Frame location tolerance according to X ± 20 mm

X - Bathtub drain centre  
Y - Suggested floor drainage area